

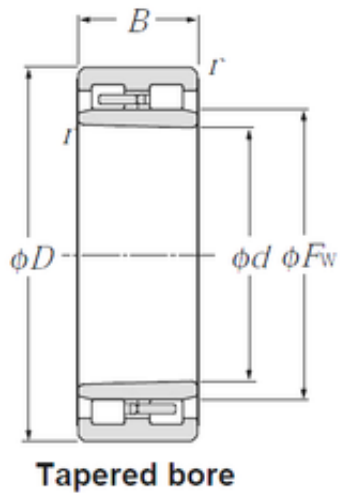

China Kubota Hydraulic Final Drive Mo...



NNU4956K NTN Cylindrical Roller Bearing

Bearing No. NNU4956K

Size	280x380x100 mm
Bore Diameter	280 mm
Outer Diameter	380 mm
Width	100 mm
d	280 mm
Fw	312 mm
D	380 mm
B	100 mm
C	100 mm
r min.	2,1 mm
Weight	30,2 Kg
Basic dynamic load rating (C)	925 kN
Basic static load rating (C0)	2 200 kN
(Grease) Lubrication Speed	1 400 r/min

NNU4956K Bearing 2D drawings and 3D CAD models